



# Commercial Door Solutions

**Addison**  
DOOR CLOSERS



**STELLA**  
PATCH FITTINGS



1300 4 ELITE

# Addison

## Patch Closers



The ultimate in style, functionality, reliability and performance, the Addison Patch Closer is the perfect choice for your glass door or pool gate operator.

Eliminating the need to dig holes for floor springs, the Addison patch closer facilitates faster installation while maintaining the integrity of the concrete slab.

Fully adjustable closing and latching speeds combined with multi-directional adjusting base plate delivers precise fitting and excellent performance on every installation.

- ADD100 for 740mm to 1000mm wide doors
- ADD105 for 1000mm to 1200mm wide doors
- Glass Thickness 10mm to 15mm
- Tested and conforms to EN1154
- Available in Hold Open and Non Hold Open
- Adjustable closing and latching speeds
- PSS = Polished Stainless Steel  
SSS = Satin Stainless Steel  
MB = Matt Black
- Fast installation without need to cut concrete



### ADD 100 Medium Duty Patch Closer

Description	Type	Code
<b>ADD 100</b> Medium Duty Hydraulic Patch Closer  <b>750mm to 1000mm</b> doors  <b>100kg</b> maximum weight	Hold Open	ADD.100 HO PSS
		ADD.100 HO SSS
		ADD.100 HO MB
	Non Hold Open	ADD.100 NHO PSS
		ADD.100 NHO SSS
		ADD.100 NHO MB

### ADD 105 Heavy Duty Patch Closer

Description	Type	Code
<b>ADD 105 Heavy</b> Duty Hydraulic Patch Closer  <b>1000mm to 1200mm</b> doors  <b>100kg</b> maximum weight	Hold Open	ADD.105 HO PSS
		ADD.105 HO SSS
		ADD.105 HO MB
	Non Hold Open	ADD.105 NHO PSS
		ADD.105 NHO SSS
		ADD.105 NHO MB

# Addison

## Floor Springs



ADD820  
ADD840  
ADD860



ADD880

Product Code	ADD.820	ADD.840	ADD.860	ADD.880
Closing Force (Nm)	16Nm	26Nm	33Nm	23-56Nm
Maximum Door Width	900	1000	1100	1400
Maximum Door Weight	120kg	120kg	150kg	300kg
Interchangeable Spindles	5mm to 50mm in 5mm increments			
90 deg Hold Open (HO)	✓	✓	✓	✓
Non Hold Open (NHO)	✓	✓	✓	✓
Dimension of Cement box				
Length (mm)		307		341
Width (mm)		108		78
Depth (mm)		40		60
Adjustment in Cement Case				
Length (mm)		7		6
Width (mm)		10		6
Height (mm)		4		4

Addison Floorsprings offer outstanding performance for all door operating applications.

From 16Nm through to 56Nm, hold open and non hold open, interchangeable spindles from 5 to 50mm, and a 10 year warranty, there's a floorspring to meet your exact requirements.

SPF26 Floor Bearing Pivot



SPF24 Top Pivot



# Addison

## Transom Closers



### Features and Benefits

- Adjustable closing and latching speeds
- Suitable for slimline transom extrusions
- Available in Hold Open and Non Hold Open options
- Suitable for timber and glass doors

### ADD.COC 3

- Max door width 950mm
- Max door weight 105kgs

### ADD.COC 4

- Max door width 1200mm
- Max door weight 150kgs

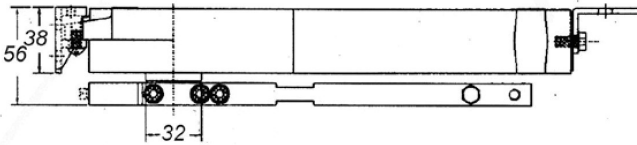

Hold open 90° or Non-Hold open

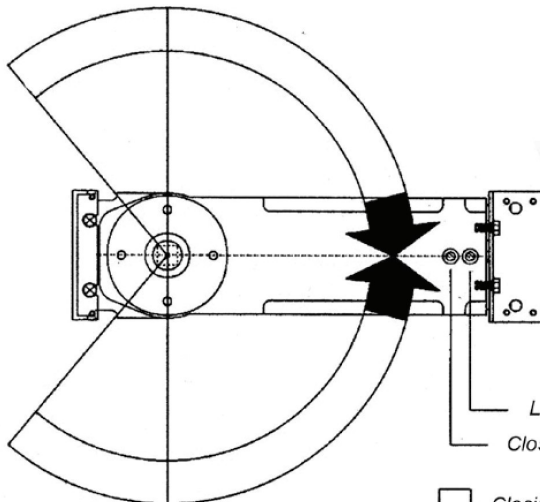
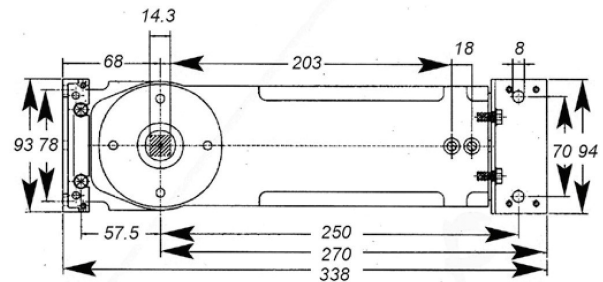

Speed Increase (⊖) Speed Decrease (⊕)

Latching Speed adjusting valve  
Closing speed adjusting valve

□ Closing range 130° - 15°

■ Latching range 15° - 0°

Hold open 90° or Non-Hold open



The fastest door rail on the market



1. Measure
  2. Cut
  3. Install
- Its that easy

Code	Description
RL1	Bottom Locking Rail
RL2	Top Locking Rail
RL2COC	Top Locking Rail to suit COC
RL3	Bottom Locking Rail
RL4	Top Locking Rail
RL4COC	Top Locking Rail to suit COC

- Fully prefabricated @1200mm and ready for you to dock and install
- Simply measure, cut and install
- There is no longer any need to wait days for rails to be fabricated
- Fully adjustable pivot points
- Locking and Non Locking options
- Brushed Satin ex stock
- Polished, Matt Black and other finishes available upon request
- Locking rails include Lockwood 590 equivalent lock



ADD820  
ADD840  
ADD860



ADD880 (300kg)



SPF24 Top Pivot



ADD.COC3  
ADD.COC4



SPF26 Floor Bearing Pivot





**SPF10** Bottom Patch Fitting

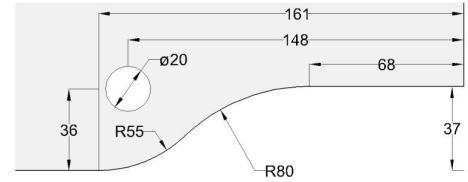

**SPF20** Top Patch Fitting

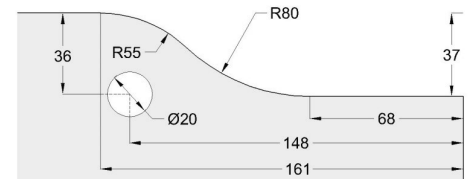

**SPF22** Top Patch Fitting to suit COC

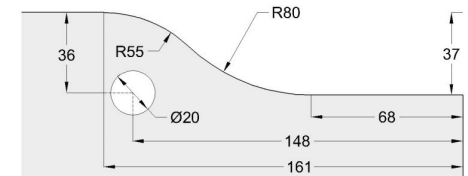

**SPF34** Top Highlight Patch with Pivot and Wall Fixing Plate

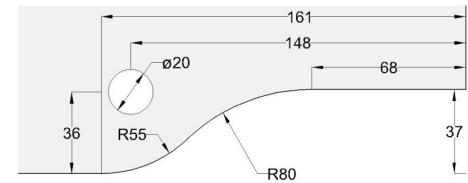

**SPF40** Overpanel/Sidepanel Patch with Pivot

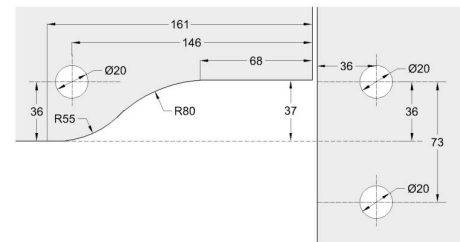

**SPF41 (L&R)** Overpanel/Sidepanel/Fin Patch with Pivot (Left and Right)

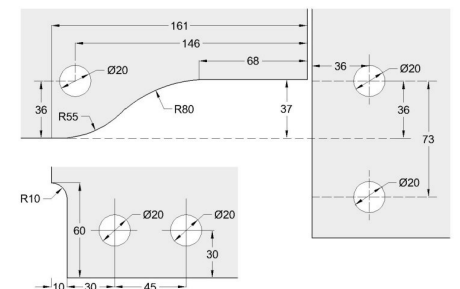

**SPF51** Highlight Pivot Patch for Double Doors

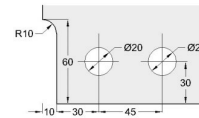
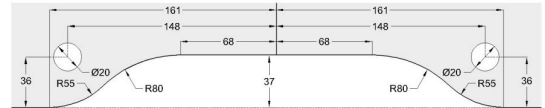

**SPF60** Overpanel/Sidepanel Patch

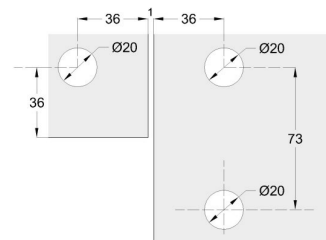

**SPF61** Overpanel/Sidepanel Patch with optional Door Stop

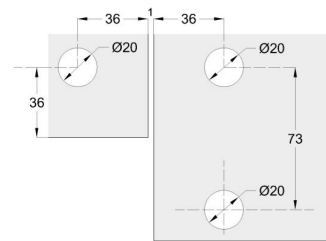

**SPF70** Highlight Patch with Double Door Stops

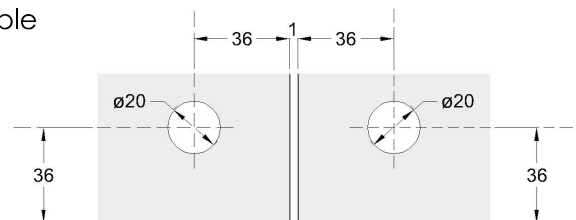

**SPF80** 4 Way Connector Patch

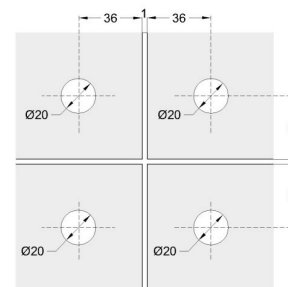

**SPF81** 4 Way Connector Patch with Fin

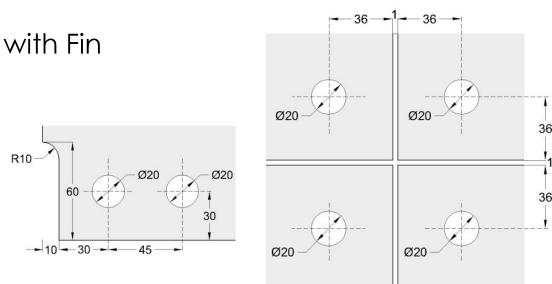

*We Love Hardware*



**Admin & Hardware  
Distribution**  
170 Derrimut Drive  
Derrimut VIC 3026

**Custom Fabrication**  
144 Derrimut Drive  
Derrimut VIC 3026

**SA Distribution**  
7 Manfulll Street  
Melrose Park SA 5039

1300 4 ELITE